

Features

- Straight Through Wiring
- Heavy Duty
- Replaceable Contacts

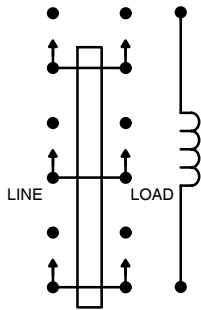

RLY600 Series

Definite Purpose, 3PST-DM, 40 Amp, Magnetic Contactors

D80

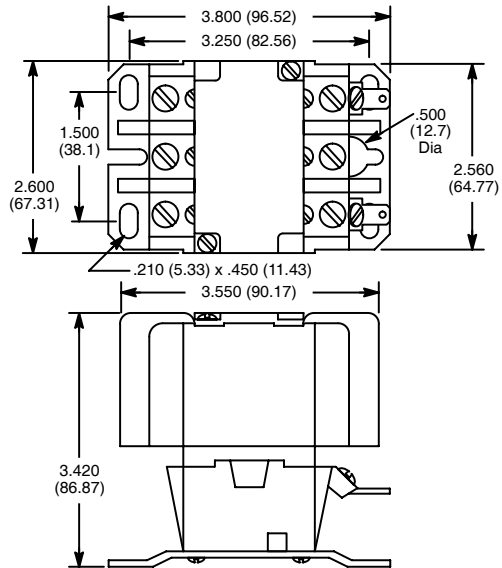

AC OPERATED					
NTE Type No.	Coils		Contacts		Diag No.
	Input Voltage	Nom. Power	Contact Arr.	Max. Contact Cur. @ 600VAC	
RLY655	120 VAC	12 VA	3PST-DM	40A	D80

Full Load	Motor Rating in Amps			Resistive Rating (Elect. Heat) @ 600VAC
	Locked Rotor			
@ 600VAC	@ 240VAC	@ 480VAC	@ 600VAC	@ 600VAC
40A	240A	200A	160A	50A

Motor Horsepower Ratings			
Motor Type	@ 240VAC	@ 240VAC	@ 440-600VAC
1Ø2P	2 HP	5 HP	-
3Ø3P	5 HP	10 HP	15 HP

ACCESSORIES	
DESCRIPTION	NTE TYPE NO.
Dual .250" Quick Connect Terminals	RLY9201
Box Lug	RLY9202
Replacement Contacts	RLY9203

Electrical Specifications

Tungsten Lamp Rating: 50A, 277VAC
Electric Discharge Lamp Rating: 50A, 277VAC (Wye)
Min. Load Current: 1 Amp @ 120VAC
Duty: Continuous

Coil

Power **Inrush:** 92VA
Steady State: 12VA

Duty: Continuous

Operational Characteristics

Timing Value **Operate Time:** 25 mS
Release Time: 25 mS

Insulation Characteristics

Initial Breakdown Voltage: 2200V RMS

Environmental Characteristics

Operating: -55°C to +65°C

Life

Mechanical: 2,000,000 Operations
Electrical: 200,000 Operations @ Full Load

Note It is not recommended to mount or operate contactors upside-down.