

Snap Action, Subminiature



Features

- Actuator: Hinge Roller Lever



NTE Type No.	Circuitry	Max. Free Position	Min. Over Travel	Max. Operating Force	Max. Differential	Diag No.
54-416	SPDT	0.76"	0.039"	50g	0.039"	S45

S45

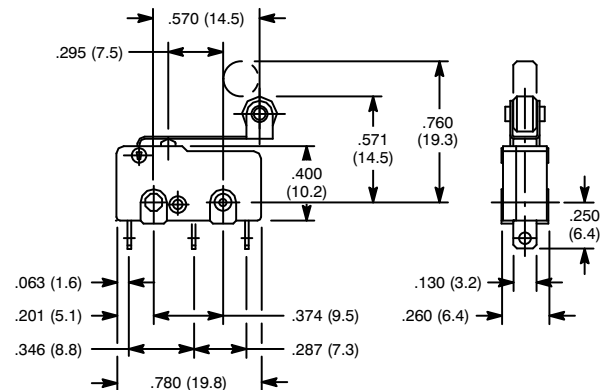

Specifications

Current Rating: 10.1A 125/250VAC, 0.4A 125VDC, 0.2A 250VDC
Contact Resistance: 30 Milliohms (max.) initial
Insulation Resistance: 100 Megohms at 500VDC
Dielectric Strength: 1000VAC (50/60Hz for 1 minute)
Temperature Rating: -13°F to +185°F (-25°C to +85°C) with no icing
Electrical Life: 50,000 cycles min. (under rated load)
Mechanical Life: 10,000,000 cycles min.
Terminal Type: Solder Terminals

Snap Action, Subminiature



Features

- Actuator: Hinge Lever



NTE Type No.	Circuitry	Max. Free Position	Min. Over Travel	Max. Operating Force	Max. Differential	Diag No.
54-417	SPDT	0.535"	0.039"	50g	0.039"	S46

S46

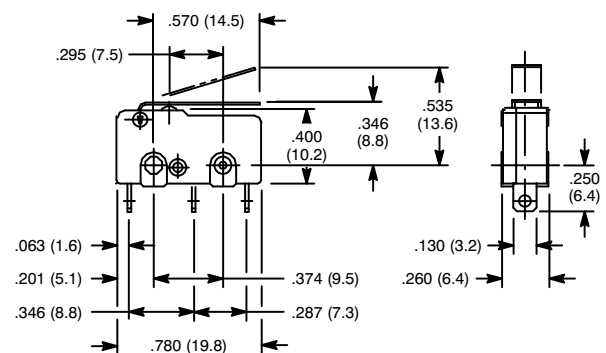

Specifications

Current Rating: 10.1A 125/250VAC, 0.4A 125VDC, 0.2A 250VDC
Contact Resistance: 30 Milliohms (max.) initial
Insulation Resistance: 100 Megohms at 500VDC
Dielectric Strength: 1000VAC (50/60Hz for 1 minute)
Temperature Rating: -13°F to +185°F (-25°C to +85°C) with no icing
Electrical Life: 50,000 cycles min. (under rated load)
Mechanical Life: 10,000,000 cycles min.
Terminal Type: Solder Terminals

Snap Action, Subminiature



Features

- Actuator: Pin Plunger



NTE Type No.	Circuitry	Max. Pre-Travel	Min. Over Travel	Max. Operating Force	Max. Differential	Diag No.
54-418	SPDT	0.024"	0.016"	150g	0.005"	S47

S47

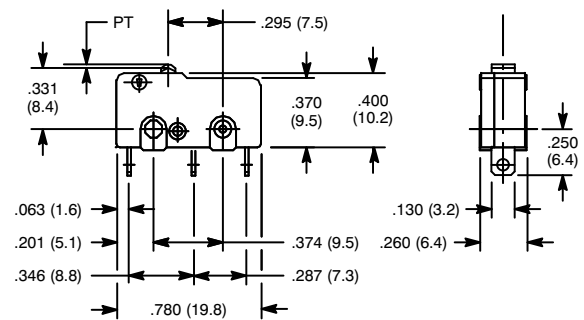

Specifications

Current Rating: 10.1A 125/250VAC, 0.4A 125VDC, 0.2A 250VDC
Contact Resistance: 30 Milliohms (max.) initial
Insulation Resistance: 100 Megohms at 500VDC
Dielectric Strength: 1000VAC (50/60Hz for 1 minute)
Temperature Rating: -13°F to +185°F (-25°C to +85°C) with no icing
Electrical Life: 50,000 cycles min. (under rated load)
Mechanical Life: 10,000,000 cycles min.
Terminal Type: Solder Terminals

Snap Action, General Purpose



Features

- Actuator: Panel Mount Plunger



NTE Type No.	Circuitry	Max. Pre-Travel	Min. Over Travel	Max. Operating Force	Max. Differential	Diag No.
54-450	SPDT	0.05"	0.22"	625g	0.01"	S39

S39

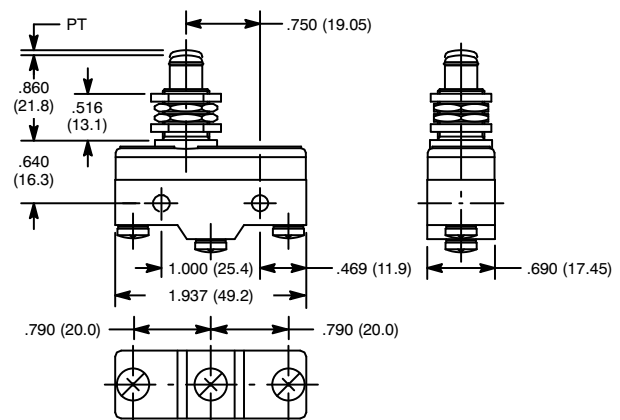

Specifications

Current Rating: 20A 125/250/480VAC, 10A 125VAC "L" (Tungsten), 0.5A 125VDC, 0.25A 250VDC, 1 HP 125VAC, 2 HP 250VA
Contact Resistance: 15 Milliohms (max.) initial
Insulation Resistance: 100 Megohms (min.) at 500VDC
Dielectric Strength: 1000VAC (50/60Hz for 1 minute)
Temperature Rating: -13°F to +176°F (-25°C to +80°C)
Electrical Life: 500,000 cycles min. (under rated load)
Mechanical Life: 1,000,000 cycles min.
Terminal Type: Screw Terminals

Snap Action, General Purpose



Features

- Actuator: Long Hinge Lever



NTE Type No.	Circuitry	Max. Pre-Travel	Min. Over Travel	Max. Operating Force	Max. Differential	Diag No.
54-451	SPDT	0.63"	0.16"	70g	0.09"	S40

S40

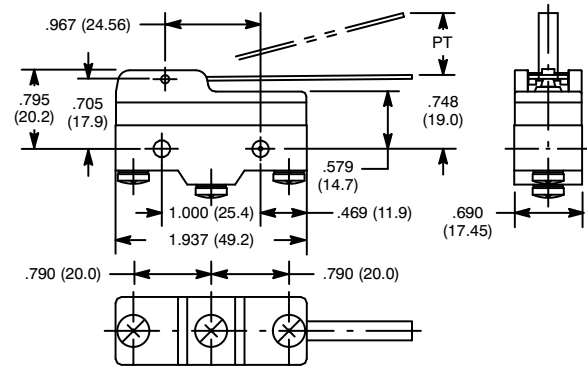

Specifications

Current Rating: 20A 125/250/480VAC, 10A 125VAC "L" (Tungsten)
0.5A 125VDC, 0.25A 250VDC, 1 HP 125VAC, 2 HP 250VA

Contact Resistance: 15 Milliohms (max.) initial

Insulation Resistance: 100 Megohms (min.) at 500VDC

Dielectric Strength: 1000VAC (50/60Hz for 1 minute)

Temperature Rating: -13°F to +176°F (-25°C to +80°C)

Electrical Life: 500,000 cycles min. (under rated load)

Mechanical Life: 1,000,000 cycles min.

Terminal Type: Screw Terminals

Snap Action, General Purpose



Features

- Actuator: Short Hinge Roller Lever



NTE Type No.	Circuitry	Max. Pre-Travel	Min. Over Travel	Max. Operating Force	Max. Differential	Diag No.
54-452	SPDT	0.25"	0.05"	160g	0.05"	S41

S41

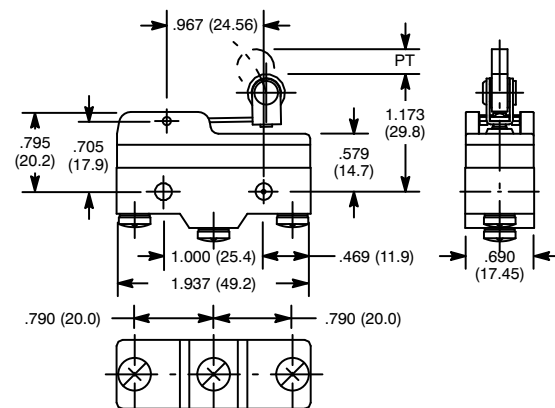

Specifications

Current Rating: 20A 125/250/480VAC, 10A 125VAC "L" (Tungsten)
0.5A 125VDC, 0.25A 250VDC, 1 HP 125VAC, 2 HP 250VA

Contact Resistance: 15 Milliohms (max.) initial

Insulation Resistance: 100 Megohms (min.) at 500VDC

Dielectric Strength: 1000VAC (50/60Hz for 1 minute)

Temperature Rating: -13°F to +176°F (-25°C to +80°C)

Electrical Life: 500,000 cycles min. (under rated load)

Mechanical Life: 1,000,000 cycles min.

Terminal Type: Screw Terminals

Snap Action, General Purpose



Features

- Actuator: Pin Plunger



NTE Type No.	Circuitry	Max. Pre-Travel	Min. Over Travel	Max. Operating Force	Max. Differential	Diag No.
54-453	SPDT	0.05"	0.01"	625g	0.01"	S42

S42

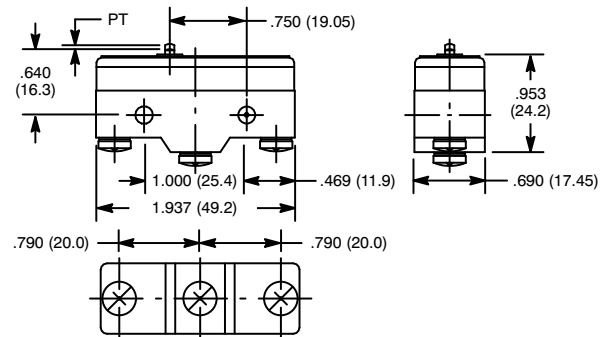

Specifications

Current Rating: 20A 125/250/480VAC, 10A 125VAC "L" (Tungsten)
0.5A 125VDC, 0.25A 250VDC, 1 HP 125VAC, 2 HP 250VA

Contact Resistance: 15 Milliohms (max.) initial

Insulation Resistance: 100 Megohms (min.) at 500VDC

Dielectric Strength: 1000VAC (50/60Hz for 1 minute)

Temperature Rating: -13°F to +176°F (-25°C to +80°C)

Electrical Life: 500,000 cycles min. (under rated load)

Mechanical Life: 1,000,000 cycles min.

Terminal Type: Screw Terminals

Snap Action, General Purpose



Features

- Actuator: Short Spring Plunger



NTE Type No.	Circuitry	Max. Pre-Travel	Min. Over Travel	Max. Operating Force	Max. Differential	Diag No.
54-454	SPDT	0.05"	0.12"	625g	0.01"	S43

S43

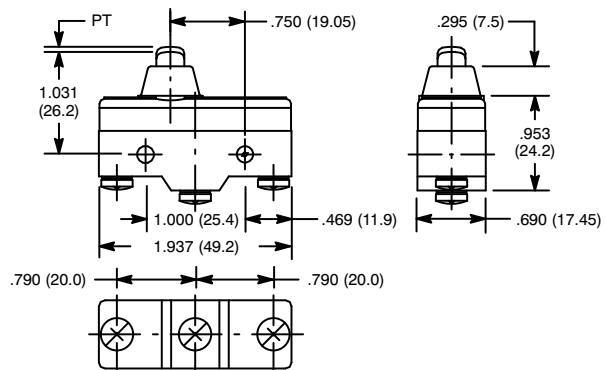

Specifications

Current Rating: 20A 125/250/480VAC, 10A 125VAC "L" (Tungsten)
0.5A 125VDC, 0.25A 250VDC, 1 HP 125VAC, 2 HP 250VA

Contact Resistance: 15 Milliohms (max.) initial

Insulation Resistance: 100 Megohms (min.) at 500VDC

Dielectric Strength: 1000VAC (50/60Hz for 1 minute)

Temperature Rating: -13°F to +176°F (-25°C to +80°C)

Electrical Life: 500,000 cycles min. (under rated load)

Mechanical Life: 1,000,000 cycles min.

Terminal Type: Screw Terminals

Snap Action, General Purpose



Features

- Actuator: Hinge Roller Lever



NTE Type No.	Circuitry	Max. Pre-Travel	Min. Over Travel	Max. Operating Force	Max. Differential	Diag No.
54-455	SPDT	0.47"	0.09"	90g	0.09"	S44

S44

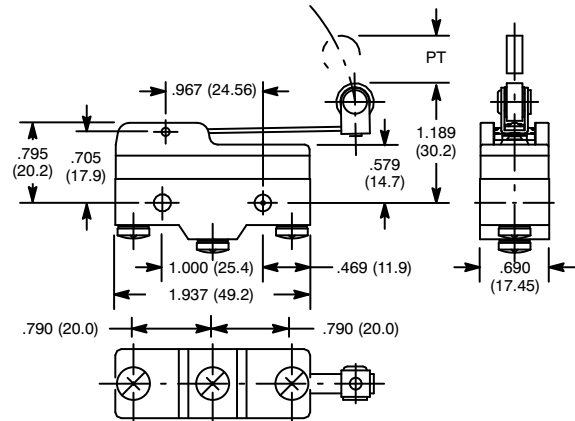

Specifications

Current Rating: 20A 125/250/480VAC, 10A 125VAC "L" (Tungsten)
0.5A 125VDC, 0.25A 250VDC, 1 HP 125VAC, 2 HP 250VA

Contact Resistance: 15 Milliohms (max.) initial

Insulation Resistance: 100 Megohms (min.) at 500VDC

Dielectric Strength: 1000VAC (50/60Hz for 1 minute)

Temperature Rating: -13°F to +176°F (-25°C to +80°C)

Electrical Life: 500,000 cycles min. (under rated load)

Mechanical Life: 1,000,000 cycles min.

Terminal Type: Screw Terminals

Snap Action, Standard



Features

- Actuator: Pin Plunger



NTE Type No.	Circuitry	Max. Pre-Travel	Min. Over Travel	Max. Operating Force	Max. Differential	Diag No.
54-423	SPDT	0.02"	0.01"	350g	0.002"	S48a
54-435	SPDT	0.02"	0.01"	350g	0.002"	S48b

S48

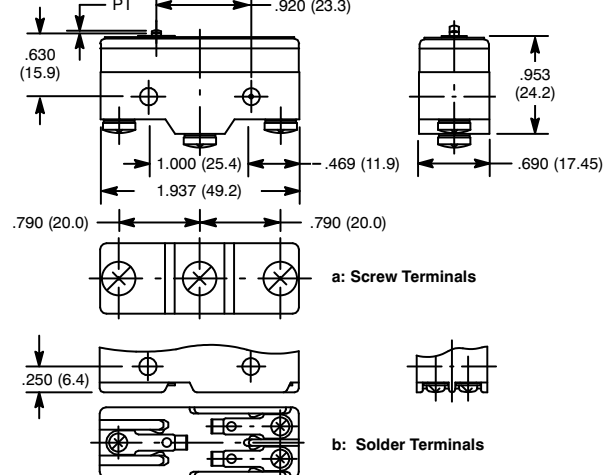

Specifications

Current Rating: 15A 125/250/480VAC, 0.5A 125VDC, 0.25A 250VDC
1/8 HP 125VAC, 1/4 HP 250VA

Contact Resistance: 50 Milliohms (max.) initial

Insulation Resistance: 100 Megohms at 500VDC

Dielectric Strength: 1000VAC (50/60Hz for 1 minute)

Temperature Rating: -13°F to +176°F (-25°C to +80°C) with no icing

Electrical Life: 500,000 cycles min. (under rated load)

Mechanical Life: 20,000,000 cycles min.

Terminal Type: Refer to Diag No. in Table

Snap Action, Standard



Features

- Actuator: Short Spring Plunger



NTE Type No.	Circuitry	Max. Pre-Travel	Min. Over Travel	Max. Operating Force	Max. Differential	Diag No.
54-424	SPDT	0.02"	0.06"	350g	0.002"	S49a
54-437	SPDT	0.02"	0.06"	350g	0.002"	S49b

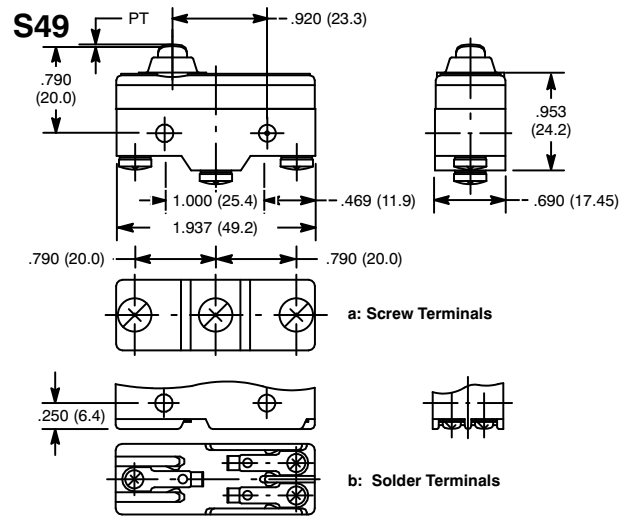

Specifications

Current Rating: 15A 125/250/480VAC, 0.5A 125VDC, 0.25A 250VDC
 1/8 HP 125VAC, 1/4 HP 250VA
Contact Resistance: 50 Milliohms (max.) initial
Insulation Resistance: 100 Megohms at 500VDC
Dielectric Strength: 1000VAC (50/60Hz for 1 minute)
Temperature Rating: -13°F to +176°F (-25°C to +80°C) with no icing
Electrical Life: 500,000 cycles min. (under rated load)
Mechanical Life: 20,000,000 cycles min.
Terminal Type: Refer to Diag No. in Table

Snap Action, Standard



Features

- Actuator: Panel Mount Plunger



NTE Type No.	Circuitry	Max. Pre-Travel	Min. Over Travel	Max. Operating Force	Max. Differential	Diag No.
54-425	SPDT	0.02"	0.22"	350g	0.002"	S50a
54-433	SPDT	0.02"	0.22"	350g	0.002"	S50b

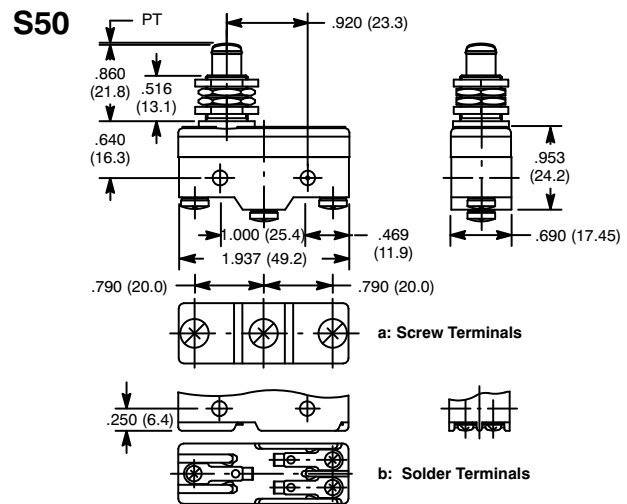

Specifications

Current Rating: 15A 125/250/480VAC, 0.5A 125VDC, 0.25A 250VDC
 1/8 HP 125VAC, 1/4 HP 250VA
Contact Resistance: 50 Milliohms (max.) initial
Insulation Resistance: 100 Megohms at 500VDC
Dielectric Strength: 1000VAC (50/60Hz for 1 minute)
Temperature Rating: -13°F to +176°F (-25°C to +80°C) with no icing
Electrical Life: 500,000 cycles min. (under rated load)
Mechanical Life: 20,000,000 cycles min.
Terminal Type: Refer to Diag No. in Table

Snap Action, Standard



Features

- Actuator: Slim Spring Plunger



NTE Type No.	Circuitry	Max. Pre-Travel	Min. Over Travel	Max. Operating Force	Max. Differential	Diag No.
54-426	SPDT	0.02"	0.06"	350g	0.002"	S51

S51

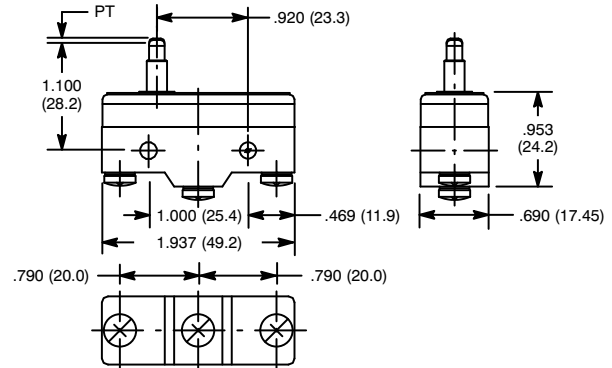

Specifications

Current Rating: 15A 125/250/480VAC, 0.5A 125VDC, 0.25A 250VDC
1/8 HP 125VAC, 1/4 HP 250VA

Contact Resistance: 50 Milliohms (max.) initial

Insulation Resistance: 100 Megohms at 500VDC

Dielectric Strength: 1000VAC (50/60Hz for 1 minute)

Temperature Rating: -13°F to +176°F (-25°C to +80°C) with no icing

Electrical Life: 500,000 cycles min. (under rated load)

Mechanical Life: 20,000,000 cycles min.

Terminal Type: Screw Terminal

Snap Action, Standard



Features

- Actuator: Long Hinge Lever

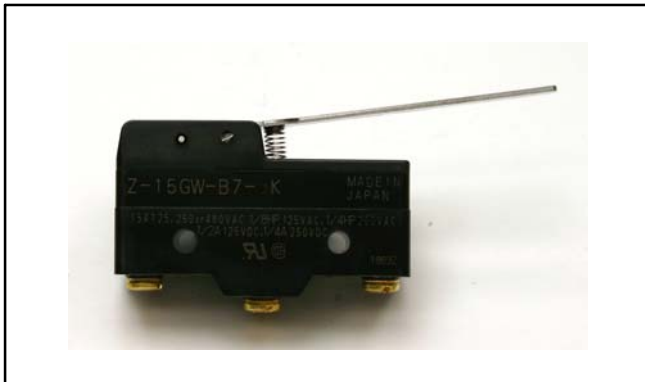

NTE Type No.	Circuitry	Max. Pre-Travel	Min. Over Travel	Max. Operating Force	Max. Differential	Diag No.
54-427	SPDT	0.022"	0.05"	70g	0.05"	S52a
54-432	SPDT	0.022"	0.05"	70g	0.05"	S52b

S52

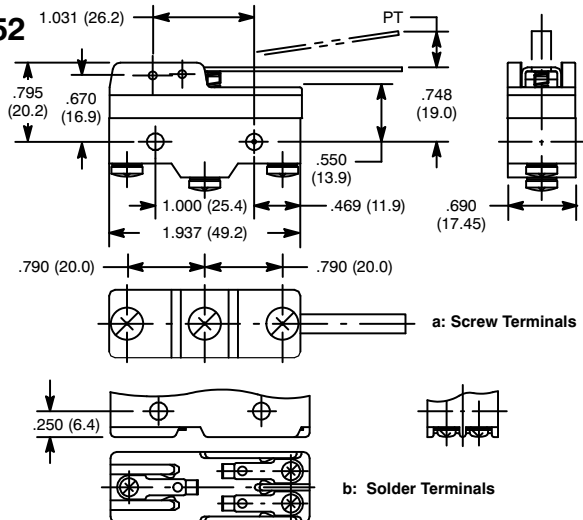

Specifications

Current Rating: 15A 125/250/480VAC, 0.5A 125VDC, 0.25A 250VDC
1/8 HP 125VAC, 1/4 HP 250VA

Contact Resistance: 50 Milliohms (max.) initial

Insulation Resistance: 100 Megohms at 500VDC

Dielectric Strength: 1000VAC (50/60Hz for 1 minute)

Temperature Rating: -13°F to +176°F (-25°C to +80°C) with no icing

Electrical Life: 500,000 cycles min. (under rated load)

Mechanical Life: 20,000,000 cycles min.

Terminal Type: Refer to Diag No. in Table

Snap Action, Standard



Features

- Actuator: Hinge Level



NTE Type No.	Circuitry	Max. Pre-Travel	Min. Over Travel	Max. Operating Force	Max. Differential	Diag No.
54-428	SPDT	0.157"	0.063"	155g	0.051"	S53

S53

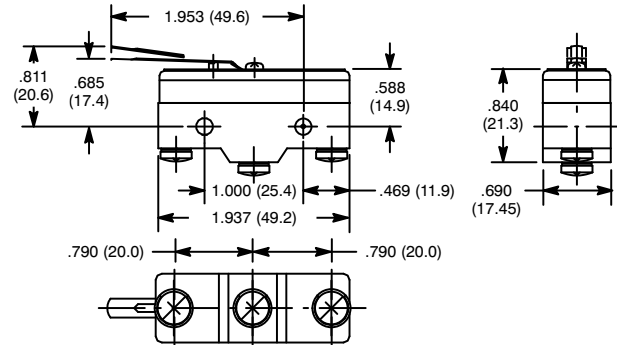

Specifications

Current Rating: 15A 125/250/480VAC, 0.5A 125VDC, 0.25A 250VDC
 1/8 HP 125VAC, 1/4 HP 250VA
Contact Resistance: 50 Milliohms (max.) initial
Insulation Resistance: 100 Megohms at 500VDC
Dielectric Strength: 1000VAC (50/60Hz for 1 minute)
Temperature Rating: -13°F to +176°F (-25°C to +80°C) with no icing
Electrical Life: 500,000 cycles min. (under rated load)
Mechanical Life: 20,000,000 cycles min.
Terminal Type: Screw Terminal

Snap Action, Standard



Features

- Actuator: Short Hinge Roller Lever



NTE Type No.	Circuitry	Max. Pre-Travel	Min. Over Travel	Max. Operating Force	Max. Differential	Diag No.
54-429	SPDT	0.22"	0.05"	70g	0.02"	S54b
54-440	SPDT	0.09"	0.095"	160g	0.02"	S54a

S54

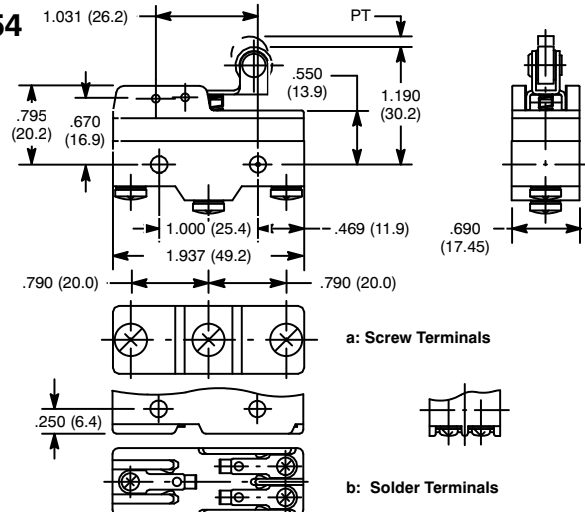

Specifications

Current Rating: 15A 125/250/480VAC, 0.5A 125VDC, 0.25A 250VDC
 1/8 HP 125VAC, 1/4 HP 250VA
Contact Resistance: 50 Milliohms (max.) initial
Insulation Resistance: 100 Megohms at 500VDC
Dielectric Strength: 1000VAC (50/60Hz for 1 minute)
Temperature Rating: -13°F to +176°F (-25°C to +80°C) with no icing
Electrical Life: 500,000 cycles min. (under rated load)
Mechanical Life: 20,000,000 cycles min.
Terminal Type: Refer to Diag No. in Table

Snap Action, Standard



Features

- Actuator: Unidirectional Short Hinge Roller Lever



NTE Type No.	Circuitry	Max. Pre-Travel	Min. Over Travel	Max. Operating Force	Max. Differential	Diag No.
54-430	SPDT	0.09"	0.02"	170g	0.02"	S55

S55

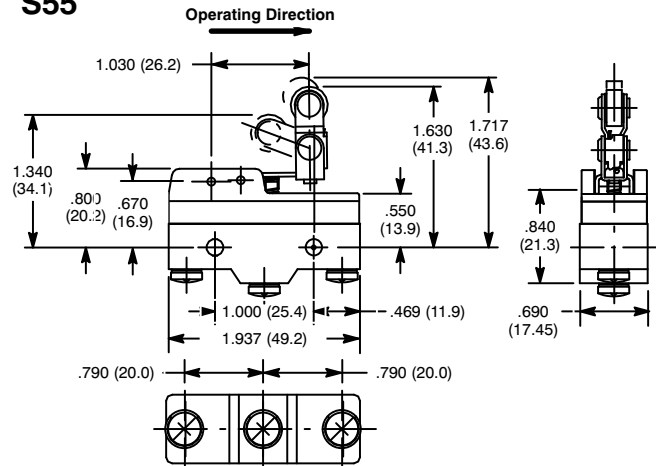

Specifications

Current Rating: 15A 125/250/480VAC, 0.5A 125VDC, 0.25A 250VDC
1/8 HP 125VAC, 1/4 HP 250VA

Contact Resistance: 50 Milliohms (max.) initial

Insulation Resistance: 100 Megohms at 500VDC

Dielectric Strength: 1000VAC (50/60Hz for 1 minute)

Temperature Rating: -13°F to +176°F (-25°C to +80°C) with no icing

Electrical Life: 500,000 cycles min. (under rated load)

Mechanical Life: 20,000,000 cycles min.

Terminal Type: Screw Terminal

Snap Action, Standard



Features

- Actuator: Panel Mount Roller Plunger



NTE Type No.	Circuitry	Max. Pre-Travel	Min. Over Travel	Max. Operating Force	Max. Differential	Diag No.
54-438	SPDT	0.02"	0.22"	350g	0.002"	S56

S56

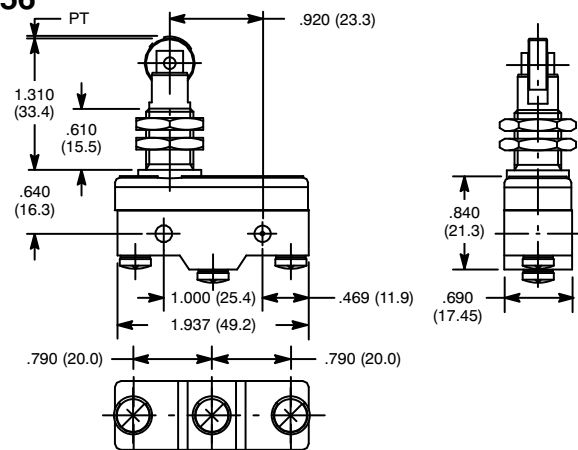

Specifications

Current Rating: 15A 125/250/480VAC, 0.5A 125VDC, 0.25A 250VDC
1/8 HP 125VAC, 1/4 HP 250VA

Contact Resistance: 50 Milliohms (max.) initial

Insulation Resistance: 100 Megohms at 500VDC

Dielectric Strength: 1000VAC (50/60Hz for 1 minute)

Temperature Rating: -13°F to +176°F (-25°C to +80°C) with no icing

Electrical Life: 500,000 cycles min. (under rated load)

Mechanical Life: 20,000,000 cycles min.

Terminal Type: Screw Terminal

Snap Action, Standard



Features

- Actuator: Hinge Roller Lever



S57

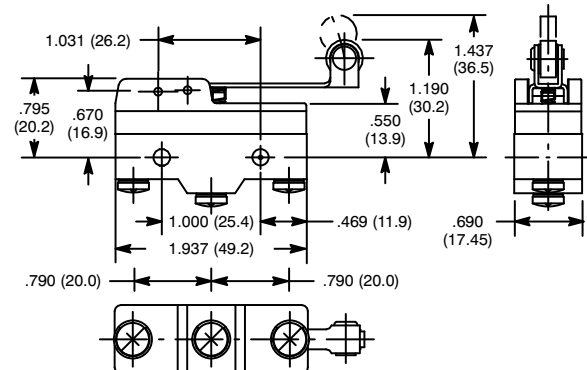

NTE Type No.	Circuitry	Max. Pre-Travel	Min. Over Travel	Max. Operating Force	Max. Differential	Diag No.
54-441	SPDT	0.16"	0.04"	100g	0.04"	S57

Specifications

Current Rating: 15A 125/250/480VAC, 0.5A 125VDC, 0.25A 250VDC
 1/8 HP 125VAC, 1/4 HP 250VA
Contact Resistance: 50 Milliohms (max.) initial
Insulation Resistance: 100 Megohms at 500VDC
Dielectric Strength: 1000VAC (50/60Hz for 1 minute)
Temperature Rating: -13°F to +176°F (-25°C to +80°C) with no icing
Electrical Life: 500,000 cycles min. (under rated load)
Mechanical Life: 20,000,000 cycles min.
Terminal Type: Screw Terminal

Snap Action, Standard



Features

- Actuator: Panel Mount Cross Roller Plunger



S58

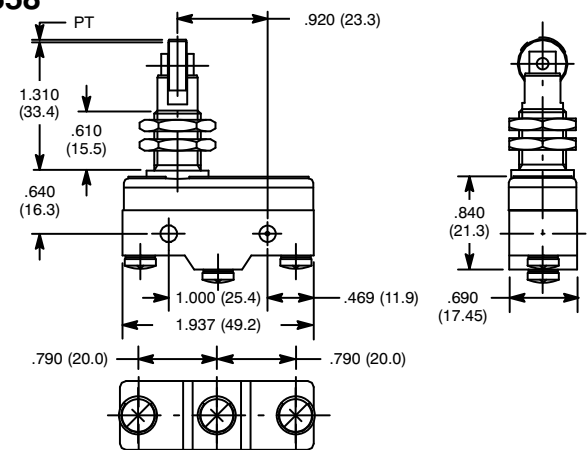

NTE Type No.	Circuitry	Max. Pre-Travel	Min. Over Travel	Max. Operating Force	Max. Differential	Diag No.
54-442	SPDT	0.02"	0.14"	350g	0.002"	S58

Specifications

Current Rating: 15A 125/250/480VAC, 0.5A 125VDC, 0.25A 250VDC
 1/8 HP 125VAC, 1/4 HP 250VA
Contact Resistance: 50 Milliohms (max.) initial
Insulation Resistance: 100 Megohms at 500VDC
Dielectric Strength: 1000VAC (50/60Hz for 1 minute)
Temperature Rating: -13°F to +176°F (-25°C to +80°C) with no icing
Electrical Life: 500,000 cycles min. (under rated load)
Mechanical Life: 20,000,000 cycles min.
Terminal Type: Screw Terminal

Snap Action, Standard



Features

- Actuator: Hinge Roller Lever



NTE Type No.	Circuitry	Max. Pre-Travel	Min. Over Travel	Max. Operating Force	Max. Differential	Diag No.
54-400	SPDT	0.13"	0.09"	125g	0.03"	S59a
54-405	SPDT	0.13"	0.09"	125g	0.03"	S59b
54-406	SPDT	0.13"	0.09"	60g	0.03"	S59a

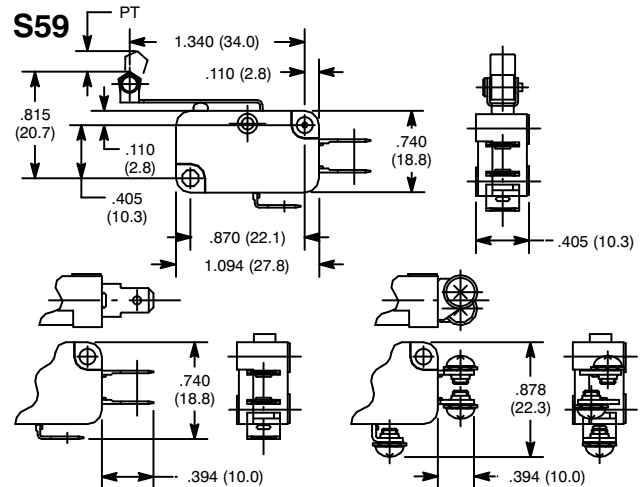

a: Quick Connect Terminals

b: Screw Terminals

Specifications

Current Rating: 15A 250VAC, 0.1A 125VDC (54-400, 54-405)
10A 250VAC, 0.1A 125VDC (54-406)

Contact Resistance: 15 Milliohms (15A); 30 Milliohms (10A)(max.) initial

Insulation Resistance: 100 Megohms at 500VDC

Dielectric Strength: 1000VAC between non-continuous terminals

Temperature Rating: -13°F to +176°F (-25°C to +80°C)

Electrical Life: 100,000 (15A); 300,000 (10A) cycles min. (under rated load)

Mechanical Life: 50,000,000 cycles min.

Terminal Type: Refer to Diag No. in Table

Snap Action, Standard



Features

- Actuator: Short Hinge Roller Lever



NTE Type No.	Circuitry	Max. Pre-Travel	Min. Over Travel	Max. Operating Force	Max. Differential	Diag No.
54-401	SPDT	0.06"	0.04"	240g	0.02"	S60b
54-407	SPDT	0.06"	0.04"	240g	0.02"	S60a
54-408	SPDT	0.06"	0.04"	120b	0.02"	S60a

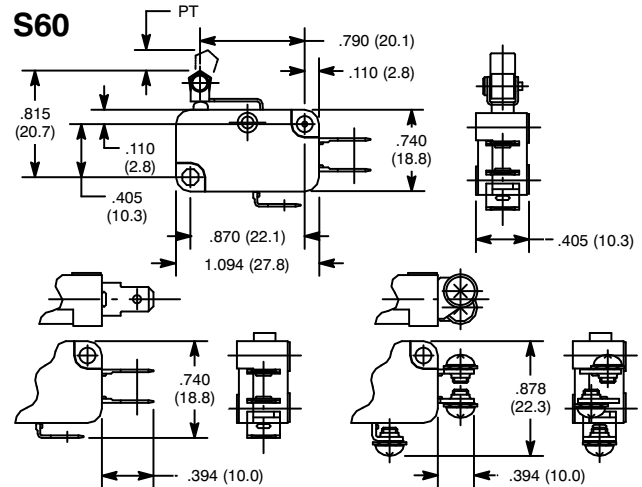

a: Quick Connect Terminals

b: Screw Terminals

Specifications

Current Rating: 15A 250VAC, 0.1A 125VDC (54-401)
10A 250VAC, 0.1A 125VDC (54-407, 54-408)

Contact Resistance: 15 Milliohms (15A); 30 Milliohms (10A)(max.) initial

Insulation Resistance: 100 Megohms at 500VDC

Dielectric Strength: 1000VAC between non-continuous terminals

Temperature Rating: -13°F to +176°F (-25°C to +80°C)

Electrical Life: 100,000 (15A); 300,000 (10A) cycles min. (under rated load)

Mechanical Life: 50,000,000 cycles min.

Terminal Type: Screw Terminals

Snap Action, Standard



Features

- Actuator: Simulated Roller Lever



NTE Type No.	Circuitry	Max. Pre-Travel	Min. Over Travel	Max. Operating Force	Max. Differential	Diag No.
54-402	SPDT	0.13"	0.09"	125g	0.03"	S61
54-422	SPDT	0.13"	0.09"	60g	0.03"	S61

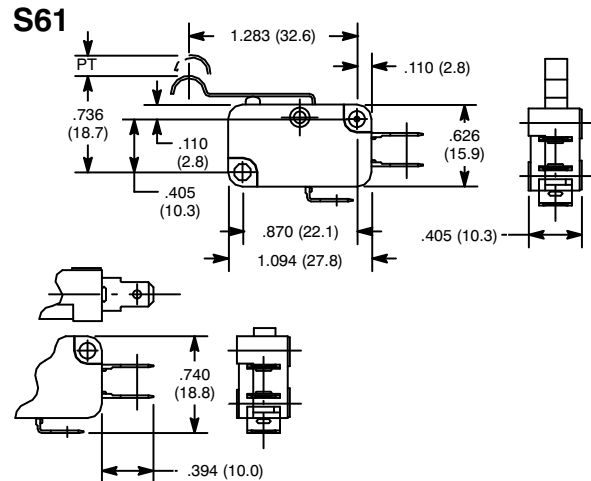

Quick Connect Terminals

Specifications

Current Rating: 15A 250VAC, 0.1A 125VDC (54-402)
10A 250VAC, 0.1A 125VDC (54-422)

Contact Resistance: 15 Milliohms (15A); 30 Milliohms (10A)(max.) initial

Insulation Resistance: 100 Megohms at 500VDC

Dielectric Strength: 1000VAC between non-continuous terminals

Temperature Rating: -13°F to +176°F (-25°C to +80°C)

Electrical Life: 100,000 (15A); 300,000 (10A) cycles min. (under rated load)

Mechanical Life: 50,000,000 cycles min.

Terminal Type: .187" Quick Connect Terminals

Snap Action, Standard



Features

- Actuator: Hinge Lever



NTE Type No.	Circuitry	Max. Pre-Travel	Min. Over Travel	Max. Operating Force	Max. Differential	Diag No.
54-403	SPDT	0.13"	0.09"	125g	0.03"	S62
54-414	SPDT	0.13"	0.09"	60g	0.03"	S62

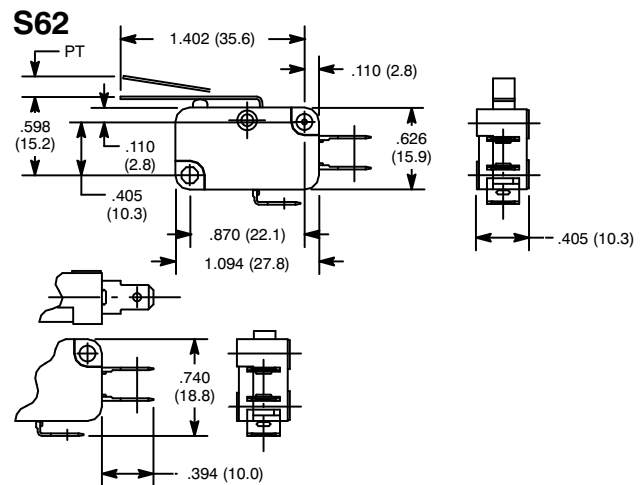

Quick Connect Terminals

Specifications

Current Rating: 15A 250VAC, 0.1A 125VDC (54-403)
10A 250VAC, 0.1A 125VDC (54-414)

Contact Resistance: 15 Milliohms (max.) initial

Insulation Resistance: 100 Megohms at 500VDC

Dielectric Strength: 1000VAC between non-continuous terminals

Temperature Rating: -13°F to +176°F (-25°C to +80°C)

Electrical Life: 100,000 cycles min. (under rated load)

Mechanical Life: 50,000,000 cycles min.

Terminal Type: .187" Quick Connect Terminals

Snap Action, Standard



Features

- Actuator: Pin Plunger



S63

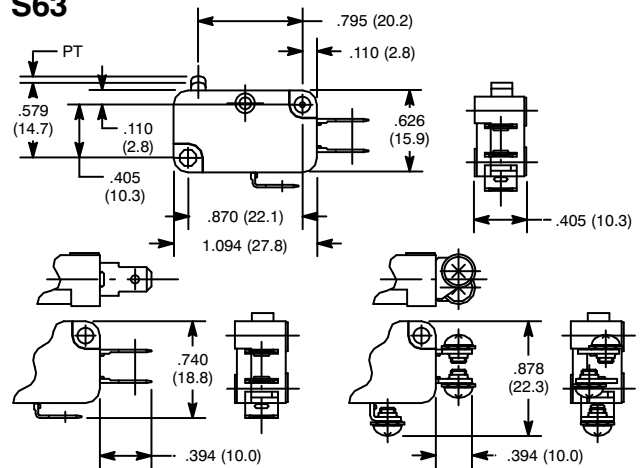

a: Quick Connect Terminals

b: Screw Terminals

NTE Type No.	Circuitry	Max. Pre-Travel	Min. Over Travel	Max. Operating Force	Max. Differential	Diag No.
54-404	SPDT	0.06"	0.04"	100g	0.02"	S63a
54-411	SPDT	0.05"	0.05"	100g	0.01"	S63a
54-412	SPST-NC	0.05"	0.05"	100g	0.01"	S63a
54-413	SPST-NO	0.05"	0.05"	100g	0.01"	S63a
54-415	SPDT	0.05"	0.05"	200g	0.01"	S63b
54-419	SPDT	0.05"	0.05"	200g	0.01"	S63a
54-420	SPDT	0.05"	0.05"	200g	0.01"	S63a

Specifications

Current Rating: 15A 250VAC, 0.1A 125VDC (54-404, 54-419 ONLY)
10A 250VAC, 0.1A 125VDC

Contact Resistance: 15 Milliohms (15A); 30 Milliohms (10A)(max.) initial

Insulation Resistance: 100 Megohms at 500VDC

Dielectric Strength: 1000VAC between non-continuous terminals

Temperature Rating: -13°F to +176°F (-25°C to +80°C)

Electrical Life: 100,000 (15A); 300,000 (10A) cycles min. (under rated load)

Mechanical Life: 50,000,000 cycles min.

Terminal Type: Refer to Diag No. in Table

Snap Action, Standard



Features

- Actuator: Long Hinge Lever



S64

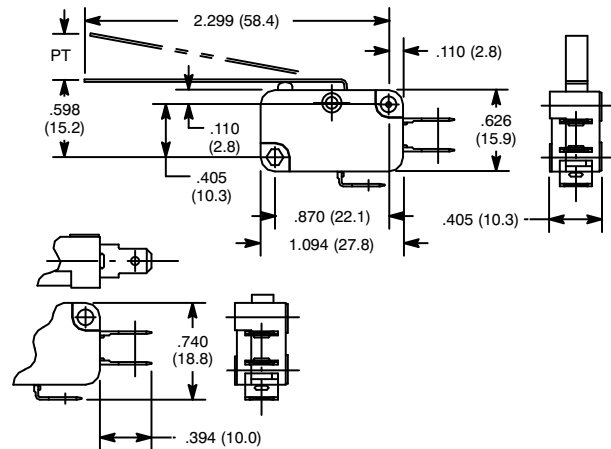

Quick Connect Terminals

NTE Type No.	Circuitry	Max. Pre-Travel	Min. Over Travel	Max. Operating Force	Max. Differential	Diag No.
54-409	SPDT	0.30"	0.13"	35g	0.08"	S64
54-410	SPDT	0.35"	0.12"	70g	0.08"	S64

Specifications

Current Rating: 10A 250VAC, 0.1A 125VDC

Contact Resistance: 30 Milliohms (max.) initial

Insulation Resistance: 100 Megohms at 500VDC

Dielectric Strength: 1000VAC between non-continuous terminals

Temperature Rating: -13°F to +176°F (-25°C to +80°C)

Electrical Life: 300,000 cycles min. (under rated load)

Mechanical Life: 50,000,000 cycles min.

Terminal Type: .187" Quick Connect Terminals

Snap Action, Standard



Features

- Actuator: Short Hinge Lever



NTE Type No.	Circuitry	Max. Pre-Travel	Min. Over Travel	Max. Operating Force	Max. Differential	Diag No.
54-421	SPDT	0.05"	0.05"	200g	0.01"	S65

S65

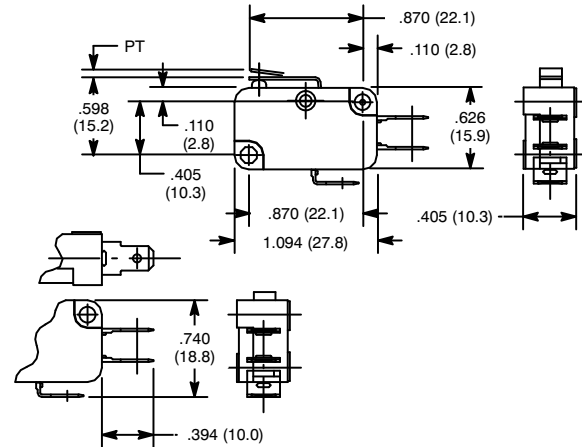

Quick Connect Terminals

Specifications

- Current Rating:** 10A 250VAC, 0.1A 125VDC
- Contact Resistance:** 30 Milliohms (max.) initial
- Insulation Resistance:** 100 Megohms at 500VDC
- Dielectric Strength:** 1000VAC between non-continuous terminals
- Temperature Rating:** -13°F to +176°F (-25°C to +80°C)
- Electrical Life:** 300,000 cycles min. (under rated load)
- Mechanical Life:** 50,000,000 cycles min.
- Terminal Type:** .187" Quick Connect Terminals